

1.25Gb/s 80km DWDM SFP Transceiver

Hot Pluggable, Duplex LC, +3.3V, 100GHz, DWDM COOLED DFB&PIN, Single mode

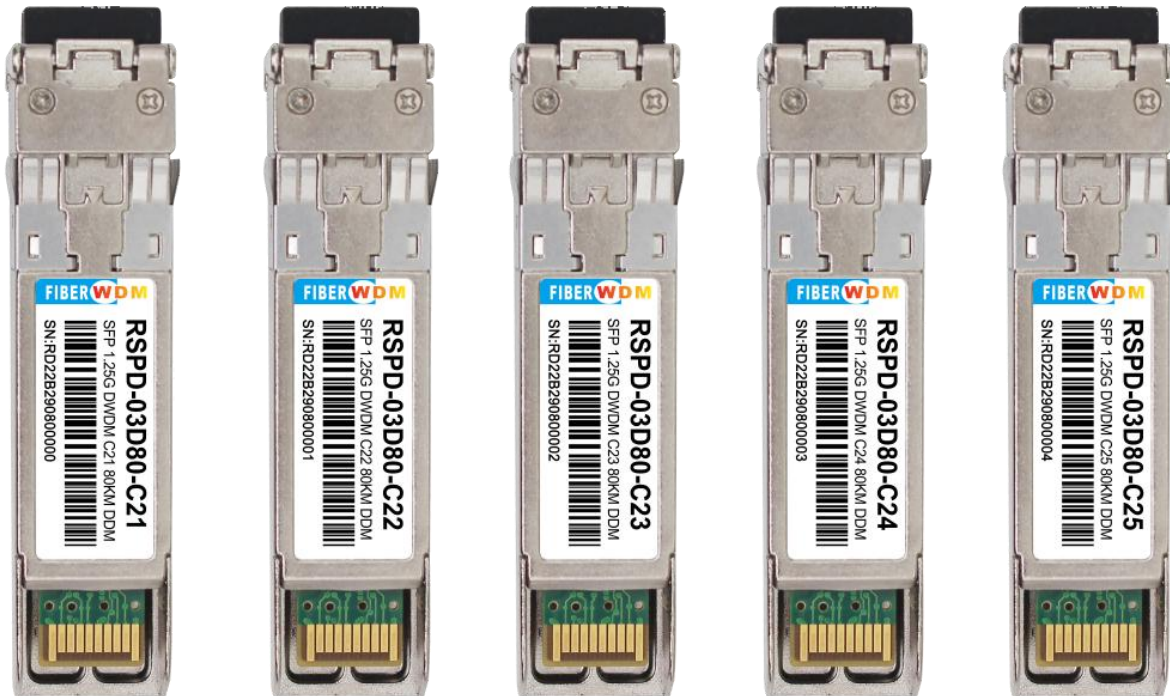

Features:

- ◆ Hot-Pluggable
- ◆ Duplex LC connector
- ◆ Up to 2.67Gb/s data rate
- ◆ 100GHz ITU Grid, C Band
- ◆ DWDM COOLED DFB transmitter, PINTIA photo-detector
- ◆ SMF links up to 80km
- ◆ 2-wire interface for management specifications compliant with SFF 8472 digital diagnostic monitoring interface
- ◆ Power Supply :+3.3V
- ◆ Power consumption<1.5W
- ◆ Temperature Range: 0~ 70°C
- ◆ RoHS compliant

Applications:

- ◆ 1G Fibre channel
- ◆ DWDM Networks
- ◆ Fibre channel

Description:

FIBERWDM's RSPD-03D80-Cxx is a very compact 1.25Gb/s optical transceiver module for serial optical communication applications at 1.25Gb/s. The RSPD-03D80-Cxx converts a 1.25Gb/s serial electrical data stream to 2.67Gb/s optical output signal and a 1.25Gb/s optical input signal to 1.25Gb/s serial electrical data streams. The high speed 2.67Gb/s electrical interface is fully compliant with SFI specification.

The high performance DWDM COOLED DFB transmitter and high sensitivity PINTIA receiver provide superior performance for Ethernet applications at up to 80km links.

The SFP Module compliants with SFF-8431, SFF-8432 Digital diagnostics functions are available via a 2-wire serial interface, as specified in SFF-8472.

The fully SFP compliant form factor provides hot pluggability, easy optical port upgrades and low EMI emission.

● Absolute Maximum Ratings

Parameter	Symbol	Min.	Typical	Max.	Unit
Storage Temperature	T_S	-40		+85	°C
Case Operating Temperature	T_A	0		70	°C
Maximum Supply Voltage	Vcc	-0.5		4	V
Relative Humidity	RH	0		85	%

● Electrical Characteristics ($T_{OP} = 0$ to 70 °C, VCC = 3.135 to 3.465 Volts)

Parameter	Symbol	Min.	Typical	Max.	Unit	Note
Supply Voltage	Vcc	3.135		3.465	V	
Supply Current	Icc			450	mA	
Power Consumption	P			1.5	W	
Transmitter Section:						
Input differential impedance	R_{in}		100		Ω	1

Tx Input Single Ended DC Voltage Tolerance (Ref VeeT)	V	-0.3		4	V	
Differential input voltage swing	V _{in,pp}	180		700	mV	2
Transmit Disable Voltage	V _D	2		V _{cc}	V	3
Transmit Enable Voltage	V _{EN}	V _{ee}		V _{ee} +0.8	V	
Receiver Section:						
Single Ended Output Voltage Tolerance	V	-0.3		4	V	
Rx Output Diff Voltage	V _o	300		850	mV	
Rx Output Rise and Fall Time	Tr/Tf	30			ps	4
LOS Fault	V _{LOS fault}	2		V _{CCHOST}	V	5
LOS Normal	V _{LOS norm}	V _{ee}		V _{ee} +0.8	V	5

Note:

1. Connected directly to TX data input pins. AC coupling from pins into laser driver IC.
2. Per SFF-8431 Rev 3.0
3. Into 100 ohms differential termination.
4. 20%~80%
5. LOS is an open collector output. Should be pulled up with 4.7k – 10kΩ on the host board. Normal operation is logic 0; loss of signal is logic 1. Maximum pull-up voltage is 5.5V.

● Optical Parameters(TOP = 0 to 70°C, VCC = 3.135 to 3.465 Volts)

Parameter	Symbol	Min.	Typical	Max.	Unit	Note
Transmitter Section:						
Optical Wavelength-End Of Life	λ	X-100	X	X+100	pm	
Optical Wavelength-Beginning Of Life	λ	X-25	X	X+25	pm	
Average Optical Power	P _{avg}	0		+5	dBm	1
Laser Off Power	P _{off}			-30	dBm	
Extinction Ratio	ER	8.2			dB	
Transmitter Dispersion Penalty	TDP			3.0	dB	
Relative Intensity Noise	R _{in}			-128	dB/Hz	2
Optical Return Loss Tolerance		20			dB	
Receiver Section:						
Center Wavelength	λ _r	1480		1580	nm	
Receiver Sensitivity (OMA)	S _{en}			-24	dBm	2
Los Assert	LOS _A	-40		-	dBm	
Los Dessert	LOS _D			-33	dBm	
Los Hysteresis	LOS _H	0.5			dB	
Overload	S _{at}	0			dBm	3
Receiver Reflectance	R _{rx}			-12	dB	

Note:

1. Average power figures are informative only Fibre channel
2. 12dB reflection.
3. Receiver overload specified in OMA and under the worst comprehensive stressed condition.

● Timing Characteristics

Parameter	Symbol	Min.	Typical	Max.	Unit
TX_Disable Assert Time	t_off			10	us
TX_Disable Negate Time	t_on			1	ms
Time to Initialize Include Reset of TX_FAULT	t_int			300	ms
TX_FAULT from Fault to Assertion	t_fault			100	us
TX_Disable Time to Start Reset	t_reset	10			us
Receiver Loss of Signal Assert Time	T _A ,RX_LOS			100	us
Receiver Loss of Signal Deassert Time	T _d ,RX_LOS			100	us
Rate-Select Chage Time	t_ratesel			10	us
Serial ID Clock Time	t_serial-clock			100	kHz

● Pin Assignment

Diagram of Host Board Connector Block Pin Numbers and Name

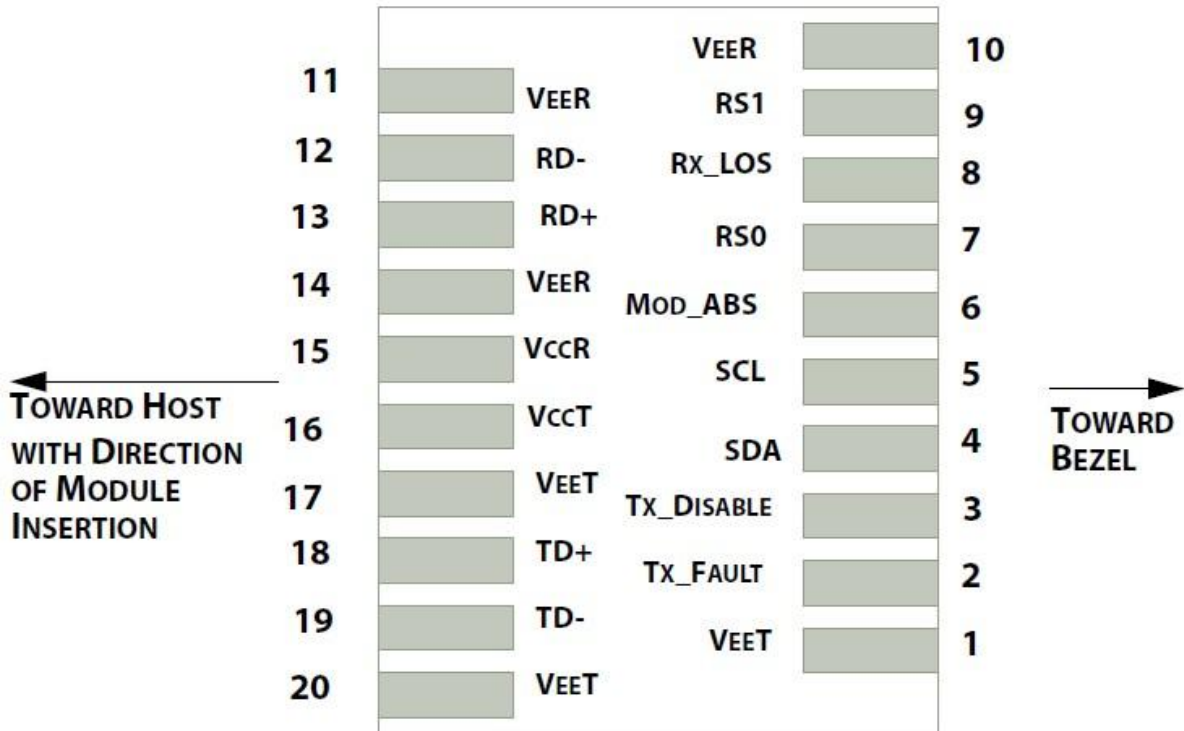

● Pin Function Definitions

PIN #	Name	Function	Notes
1	VeeT	Module transmitter ground	1
2	Tx Fault	Module transmitter fault	2
3	Tx Disable	Transmitter Disable; Turns off transmitter laser output	3
4	SDL	2 wire serial interface data input/output (SDA)	
5	SCL	2 wire serial interface clock input (SCL)	
6	MOD-ABS	Module Absent, connect to VeeR or VeeT in the module	2
7	RS0	Rate select0, optionally control SFP receiver. When high, input data rate >4.5Gb/s; when low, input data rate <=4.5Gb/s	
8	LOS	Receiver Loss of Signal Indication	4
9	RS1	Rate select0, optionally control SFP transmitter. When high, input data rate >4.5Gb/s; when low, input data rate <=4.5Gb/s	
10	VeeR	Module receiver ground	1
11	VeeR	Module receiver ground	1
12	RD-	Receiver inverted data out put	
13	RD+	Receiver non-inverted data out put	
14	VeeR	Module receiver ground	1
15	VccR	Module receiver 3.3V supply	
16	VccT	Module transmitter 3.3V supply	
17	VeeT	Module transmitter ground	1
18	TD+	Transmitter inverted data out put	
19	TD-	Transmitter non-inverted data out put	
20	VeeT	Module transmitter ground	1

Note:

1. The module ground pins shall be isolated from the module case.
2. This pin is an open collector/drain output pin and shall be pulled up with 4.7K-10Kohms to Host_Vcc on the host board.
3. This pin shall be pulled up with 4.7K-10Kohms to VccT in the module.
4. This pin is an open collector/drain output pin and shall be pulled up with 4.7K-10Kohms to Host_Vcc on the host board.

● SFP Module EEPROM Information and Management

The SFP modules implement the 2-wire serial communication protocol as defined in the SFP -8472. The serial ID information of the SFP modules and Digital Diagnostic Monitor parameters can be accessed through the I²C interface at address A0h and A2h. The memory is mapped in Table 1. Detailed ID information (A0h) is listed in Table 2. And the DDM specification at address A2h. For more details of the memory map and byte definitions, please refer to the SFF-8472, “Digital Diagnostic Monitoring Interface for Optical Transceivers”. The DDM parameters have been internally calibrated.

Table 1. Digital Diagnostic Memory Map (Specific Data Field Descriptions)

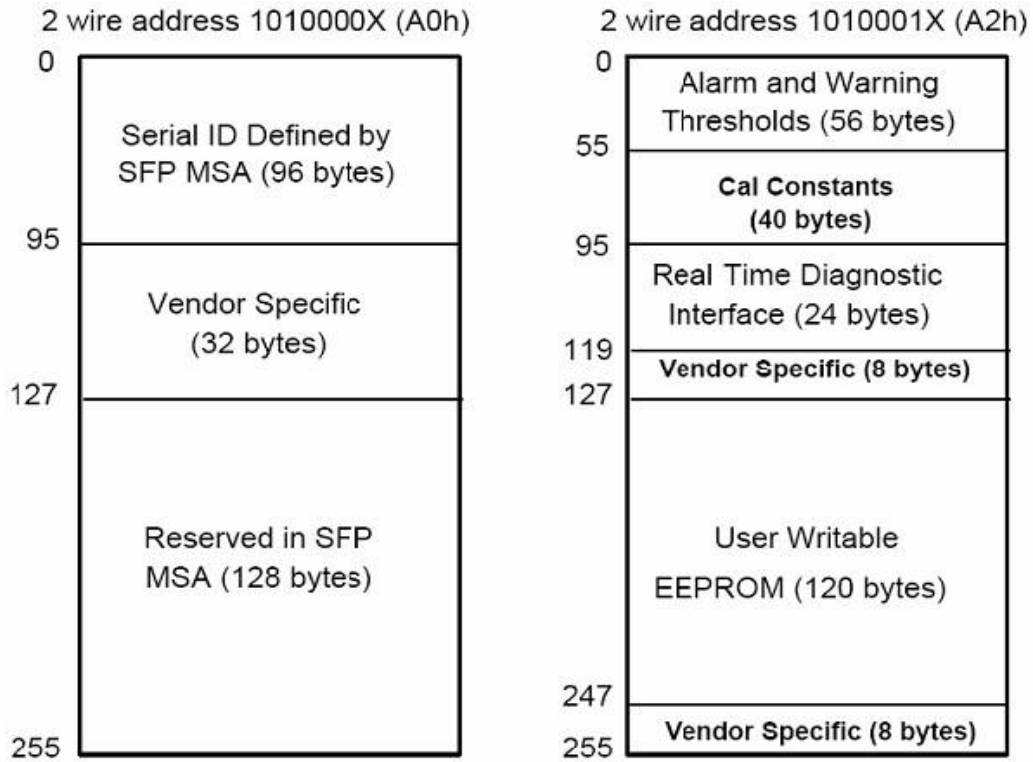

Table 2 - EEPROM Serial ID Memory Contents (A0h)

Data Address	Length (Byte)	Name of Length	Description and Contents
Base ID Fields			
0	1	Identifier	Type of Serial transceiver (03h=SFP)
1	1	Reserved	Extended identifier of type serial transceiver (04h)
2	1	Connector	Code of optical connector type (07=LC)
3-10	8	Transceiver	
11	1	Encoding	
12	1	BR, Nominal	Nominal baud rate, unit of 100Mbps
13-14	2	Reserved	(0000h)
15	1	Length(9um)	Link length supported for 9/125um fiber, units of 100m
16	1	Length(50um)	Link length supported for 50/125um fiber, units of 10m
17	1	Length(62.5um)	Link length supported for 62.5/125um fiber, units of 10m
18	1	Length(Copper)	Link length supported for copper, units of meters
19	1	Reserved	
20-35	16	Vendor Name	SFP vendor name: FIBERWDM
36	1	Reserved	
37-39	3	Vendor OUI	SFP transceiver vendor OUI ID

40-55	16	Vendor PN	Part Number: "RSPD-03D80-Cxx" (ASCII)
56-59	4	Vendor rev	Revision level for part number
60-62	3	Reserved	
63	1	CCID	Least significant byte of sum of data in address 0-62
Extended ID Fields			
64-65	2	Option	Indicates which optical SFP signals are implemented (001Ah = LOS, TX_FAULT, TX_DISABLE all supported)
66	1	BR, max	Upper bit rate margin, units of %
67	1	BR, min	Lower bit rate margin, units of %
68-83	16	Vendor SN	Serial number (ASCII)
84-91	8	Date code	FIBERWDM's Manufacturing date code
92-94	3	Reserved	
95	1	CCEX	Check code for the extended ID Fields (addresses 64 to 94)
Vendor Specific ID Fields			
96-127	32	Readable	FIBERWDM specific date, read only
128-255	128	Reserved	Reserved for SFF-8079

● Digital Diagnostic Monitor Characteristics

Data Address	Parameter	Accuracy	Unit
96-97	Transceiver Internal Temperature	±3.0	°C
98-99	VCC3 Internal Supply Voltage	±3.0	%
100-101	Laser Bias Current	±10	%
102-103	Tx Output Power	±3.0	dB
104-105	Rx Input Power	±3.0	dB

● Regulatory Compliance

The RSPD-03D80-Cxx complies with international Electromagnetic Compatibility (EMC) and international safety requirements and standards (see details in Table following).

Electrostatic Discharge (ESD) to the Electrical Pins	MIL-STD-883E Method 3015.7	Class 1(>1000 V)
Electrostatic Discharge (ESD) to the Duplex LC Receptacle	IEC 61000-4-2 GR-1089-CORE	Compatible with standards
Electromagnetic Interference (EMI)	FCC Part 15 Class B EN55022 Class B (CISPR 22B) VCCI Class B	Compatible with standards
Laser Eye Safety	FDA 21CFR 1040.10 and 1040.11	Compatible with Class 1 laser

	EN60950, EN (IEC) 60825-1,2	product.
--	-----------------------------	----------

● Recommended Circuit

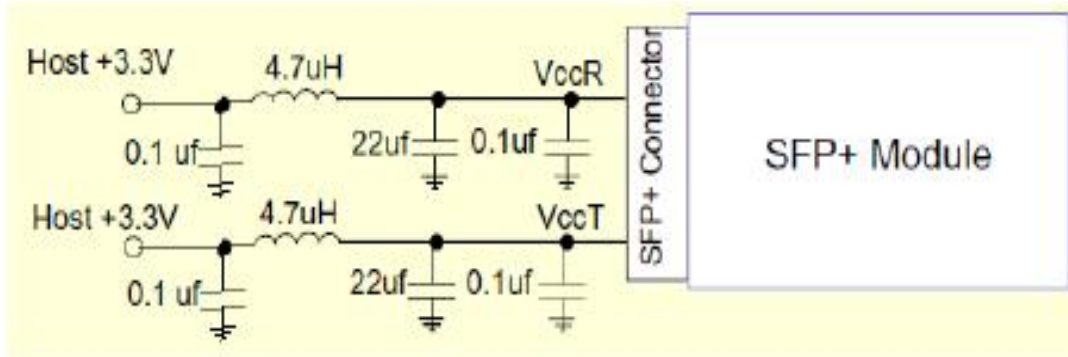

Recommended Host Board Power Supply Circuit

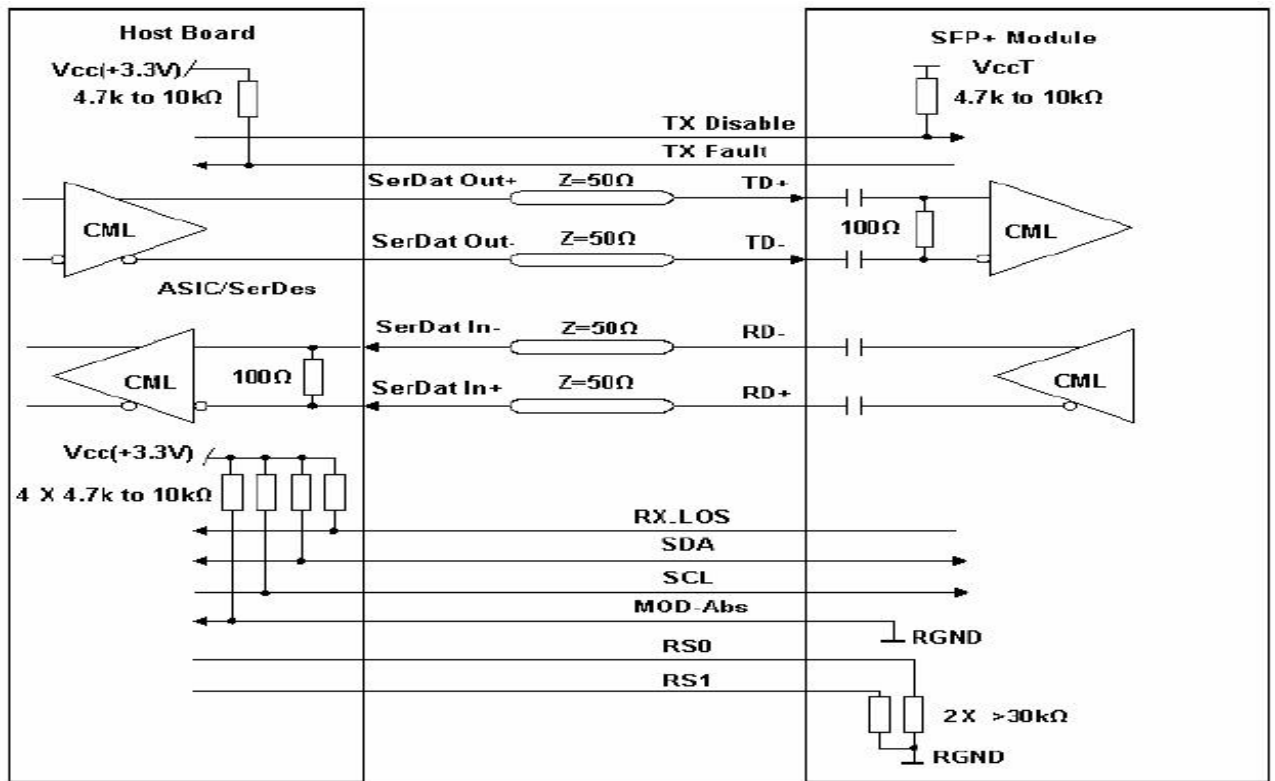

Recommended High-speed Interface Circuit

● Mechanical Dimensions

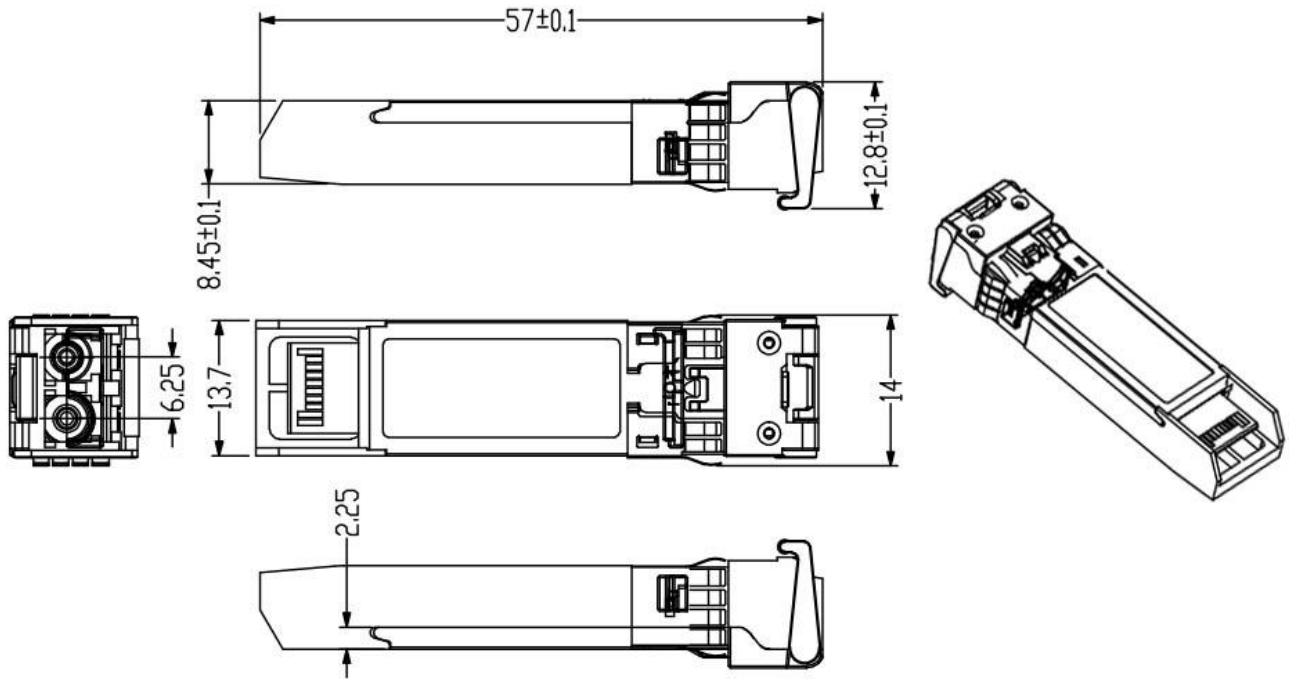

● Order Information:

Part No.	Central Wavelength(nm)	Frequency (THZ)
RSPD-03D80-C61	1528.77	196.1
RSPD-03D80-C60	1529.55	196.0
RSPD-03D80-C59	1530.33	195.9
RSPD-03D80-C58	1531.12	195.8
RSPD-03D80-C57	1531.90	195.7
RSPD-03D80-C56	1532.68	195.6
RSPD-03D80-C55	1533.47	195.5
RSPD-03D80-C54	1534.25	195.4
RSPD-03D80-C53	1535.04	195.3
RSPD-03D80-C52	1535.82	195.2
RSPD-03D80-C51	1536.61	195.1
RSPD-03D80-C50	1537.40	195.0
RSPD-03D80-C49	1538.19	194.9
RSPD-03D80-C48	1538.98	194.8
RSPD-03D80-C47	1539.77	194.7
RSPD-03D80-C46	1540.56	194.6
RSPD-03D80-C45	1541.35	194.5
RSPD-03D80-C44	1542.14	194.4

RSPD-03D80-C43	1542.94	194.3
RSPD-03D80-C42	1543.73	194.2
RSPD-03D80-C41	1544.53	194.1
RSPD-03D80-C40	1545.32	194.0
RSPD-03D80-C39	1546.12	193.9
RSPD-03D80-C38	1546.92	193.8
RSPD-03D80-C37	1547.72	193.7
RSPD-03D80-C36	1548.51	193.6
RSPD-03D80-C35	1549.32	193.5
RSPD-03D80-C34	1550.12	193.4
RSPD-03D80-C33	1550.92	193.3
RSPD-03D80-C32	1551.72	193.2
RSPD-03D80-C31	1552.52	193.1
RSPD-03D80-C30	1553.33	193.0
RSPD-03D80-C29	1554.13	192.9
RSPD-03D80-C28	1554.94	192.8
RSPD-03D80-C27	1555.75	192.7
RSPD-03D80-C26	1556.55	192.6
RSPD-03D80-C25	1557.36	192.5
RSPD-03D80-C24	1558.17	192.4
RSPD-03D80-C23	1558.98	192.3
RSPD-03D80-C22	1559.79	192.2
RSPD-03D80-C21	1560.61	192.1
RSPD-03D80-C20	1561.42	192.0
RSPD-03D80-C19	1562.23	191.9
RSPD-03D80-C18	1563.05	191.8
RSPD-03D80-C17	1563.86	191.7